



MODEL N° 1525

OWNER'S MANUAL

Keep this Product ID Number and use when contacting Customer Service:

REGISTER YOUR LIFETIME PRODUCT TODAY!

There are benefits to registering your Lifetime product. With our new online product registration form, it's fast and easy! Register with us at www.lifetime.com and enjoy these great benefits:

- Receive exclusive money-saving offers from BuyLifetime.com, our online store, as well as NEW product notifications and special closeout promotions!
- In the unlikely event of a product recall or safety modification, we will notify you.
- Registering your product guarantees you warranty service. If you do not register your product, your warranty rights will not be diminished. But you will need to provide a sales receipt to verify your product purchase date before warranty service will be provided.

LIFETIME'S PROMISE TO YOU:

Maintaining your privacy is our long-standing policy at Lifetime. And you can rest assured that Lifetime will not sell or provide your personal data to other third parties, or allow them to use your personal data for their own purposes.

We invite you to read our privacy policy at www.lifetime.com

REGISTER today!

Save this owner's manual for future reference and in the event that the manufacturer has to be contacted.

****U.S. and Canada customers ONLY****

IF ASSISTANCE IS NEEDED,

DO NOT CONTACT THE STORE!

CALL OUR CUSTOMER SERVICE DEPARTMENT at

1 (800) 225-3865

HOURS: 7:00 a.m. to 5:00 p.m. Monday through Friday (Mountain Standard Time)

Call or visit our Web site for Saturday hours

Lifetime Products, Inc.

PO Box 160010 • Freeport Center, Bldg. D-11 Clearfield, Utah 84016-0010

For customers outside the U.S. or Canada, please contact the store for assistance.



SAFETY INSTRUCTIONS



FAILURE TO FOLLOW THESE WARNINGS MAY RESULT IN SERIOUS INJURY OR PROPERTY DAMAGE AND WILL VOID WARRANTY.

To ensure safety, do not attempt to assemble this product without reading and following all instructions carefully. Check the entire box and inside all packing materials for parts and/or additional instruction material. Before beginning assembly, identify and inventory all parts and hardware using the parts and hardware lists and identifiers in this document. Proper and complete assembly, use and supervision are essential for proper orientation and to reduce the risk of accident or injury. A high probability of serious injury exists if this product is not installed, maintained, and/or operated properly. Failure to comply with any of the warnings in this instruction manual may result in serious personal injuries such as cuts, broken bones, nerve damage, paralysis, brain injury, or death. Failure to comply may also result in property damage. Please heed all warnings and cautions.

- If using a ladder during assembly, use extreme caution.
- Two capable adults are recommended for this operation.
- Check base daily for leakage. Leaks may cause product to fall.
- Assemble the pole sections properly. Failure to do so could cause the pole sections to separate during play or transport.

Most injuries are caused by misuse and/or not following instructions. Use caution when using this product.

BEFORE BEGINNING ASSEMBLY



Keep the hardware bags and their contents separate. If any parts are missing, call our Customer Service Department.



Identify and inventory all parts and hardware using the parts and hardware lists and identifiers in this document.



Test fit all Bolts by inserting them into their respective holes. If necessary, carefully scrape away any excess powder coating buildup from inside the holes. Do not scrape away all of the powder coating. Bare metal may rust. You may need to pound some Bolts into place with a hammer or mallet.



TOOLS AND PARTS REQUIRED FOR THIS ASSEMBLY

1/2" Wrench



(2)

7/16" Wrench



(2)

9/16" Wrench



(2)

3/4" Wrench



(2)

Pliers

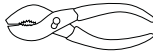

(1)

3/16" Allen Wrench



(2, included)

Phillips Screwdriver

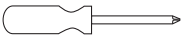

(1)

Rubber Mallet

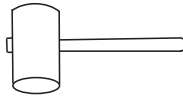

(1)

Scrap Wood



(1)

Funnel

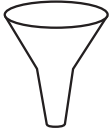

(1)

Sand



(362 lb)

Water Hose



(1)

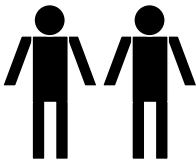

****Two adults required to complete assembly****

Only adults should set up the product. Do not allow children in the setup area until assembly is complete.

ASSEMBLY GUIDES

Refer to the following areas throughout the instructions to assist in the assembly process:

This area is located at the top, left-hand corner of the page and indicates which tools and hardware are needed to complete the assembly steps on a page.



TOOLS AND HARDWARE REQUIRED FOR THIS PAGE



This area is usually located in the bottom, left-hand corner of a step and indicates that special attention is needed to perform a particular part of a step.



Note:



These areas are usually located in the bottom, right-hand corner of a step and indicate that damage to the product or serious injury may occur if the caution or warning is not heeded.



CAUTION



WARNING



PARTS LIST

<u>ID</u>	<u>Item Description</u>	<u>Qty</u>	<u>✓</u>
ALH	Top Pole	1	<input type="checkbox"/>
ALF	Middle Pole	1	<input type="checkbox"/>
ALE	Bottom Pole	1	<input type="checkbox"/>
AJK	Right Backboard Bracket	1	<input type="checkbox"/>
AJJ	Left Backboard Bracket	1	<input type="checkbox"/>
AJI	Backboard	1	<input type="checkbox"/>
ALX	Rim	1	<input type="checkbox"/>
AKZ	Net	1	<input type="checkbox"/>
AJY	Counterbalance Spring	1	<input type="checkbox"/>
AKC	Short Extension Arm	2	<input type="checkbox"/>
AKB	Long Extension Arm	2	<input type="checkbox"/>
ALB	Outer Tube	1	<input type="checkbox"/>
AKQ	Inner Channel	1	<input type="checkbox"/>
AMN	Trigger	1	<input type="checkbox"/>
AKL	Left Handle	1	<input type="checkbox"/>
AKN	Right Handle	1	<input type="checkbox"/>
ALL	Pole Bracket	1	<input type="checkbox"/>
AJM	Base	1	<input type="checkbox"/>
ALI	Pole Brace	2	<input type="checkbox"/>
AMU	Wheel	2	<input type="checkbox"/>
AJC	1/2" x 15 3/4" Axle	1	<input type="checkbox"/>
AJE	1/2" x 7" Axle	1	<input type="checkbox"/>
AEF	Base Plug	2	<input type="checkbox"/>
AKP	Height Sticker (not shown)	1	<input type="checkbox"/>
AMT	Warning Sticker (Applied to Middle Pole)	1	<input type="checkbox"/>

HARDWARE LIST

<u>ID</u>	<u>Item Description</u>	<u>Qty</u>	<u>✓</u>
<i>Pole Assembly Hardware (1066288)</i>			
ADS	1/4" x 3/4" Screw	2	<input type="checkbox"/>
ABH	3/8" x 3 1/2" Hex Bolt	2	<input type="checkbox"/>
ADA	1/2" x 2.91" Spacer	2	<input type="checkbox"/>
AAF	3/8" Washer	2	<input type="checkbox"/>
ABB	3/8" Centerlock Nut	2	<input type="checkbox"/>
CIH	Domed Countersink Washer	2	<input type="checkbox"/>
<i>Pole to Base Assembly Hardware (1066284)</i>			
AAO	5/16" Nylock Nut	2	<input type="checkbox"/>
ABD	5/16" Washer	4	<input type="checkbox"/>
AAE	5/16" x 1" Hex Bolt	2	<input type="checkbox"/>
ABN	1/2" x 1/8" Spacer	2	<input type="checkbox"/>
BTS	1/4" Barrel Nut	1	<input type="checkbox"/>
BZO	1/4" x 3" Shoulder Bolt	1	<input type="checkbox"/>
CCL	3/16" Allen Wrench (not shown)	2	<input type="checkbox"/>

HARDWARE LIST

<u>ID</u>	<u>Item Description</u>	<u>Qty</u>	<u>✓</u>
<i>Backboard to Rim Assembly Hardware (1046640)</i>			
AAS	1/4" x 2 3/4" Hex Bolt	2	<input type="checkbox"/>
ABS	1/2" x 2 5/16" Galvanized Spacer	2	<input type="checkbox"/>
ADQ	5/16" x 1" Screw	2	<input type="checkbox"/>
AAB	1/4" Centerlock Nut	2	<input type="checkbox"/>
AAJ	5/16" Hex T-Nut	2	<input type="checkbox"/>
ABD	5/16" Washer	2	<input type="checkbox"/>
ABF	7/16" Rubber Washer	2	<input type="checkbox"/>
ABI	5/16" x 2 1/4" Tap Bolt	2	<input type="checkbox"/>
AOU	4 1/2" U-Bolt	1	<input type="checkbox"/>
ABK	5/16" Nylock Flange Nut	4	<input type="checkbox"/>
AJW	Compression Spring	2	<input type="checkbox"/>
AOW	Spring Retainer Plate	1	<input type="checkbox"/>
AOX	Rim Support Channel	1	<input type="checkbox"/>
AAV	5/16" Jam Nut	2	<input type="checkbox"/>
<i>Backboard to Pole Assembly Hardware (1047601)</i>			
ADG	1/2" x 6 5/8" Hex Bolt	4	<input type="checkbox"/>
AAX	1/2" Centerlock Nut	4	<input type="checkbox"/>
ABL	.69" x .59" Black Spacer	4	<input type="checkbox"/>
ABP	1/2" x 3/8" Clear Poly Spacer	4	<input type="checkbox"/>
<i>Handle Assembly Hardware (1046834)</i>			
AAN	5/16" Cap Nut	1	<input type="checkbox"/>
AAL	1/4" x 1 1/4" Hex Bolt	1	<input type="checkbox"/>
ABA	3/8" x 6 1/2" Hex Bolt	1	<input type="checkbox"/>
AAM	5/16" x 1 1/2" Tap Bolt	1	<input type="checkbox"/>
ADG	1/2" x 6 5/8" Hex Bolt	1	<input type="checkbox"/>
AAX	1/2" Centerlock Nut	1	<input type="checkbox"/>
AAU	1/4" Cap Nut	1	<input type="checkbox"/>
ABB	3/8" Centerlock Nut	1	<input type="checkbox"/>
AAP	#6 x 3/8" Phillips Pan Head Screw	2	<input type="checkbox"/>
ADT	#6 x 5/8" Screw	7	<input type="checkbox"/>
ACZ	.69" x 1.4" Spacer	2	<input type="checkbox"/>
AQH	Trigger Spring	1	<input type="checkbox"/>
AQG	Lock Tab	1	<input type="checkbox"/>

PARTS IDENTIFIER

Parts shown at 10% of Actual Size

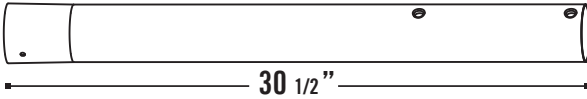

ALH (x1)
Top Pole

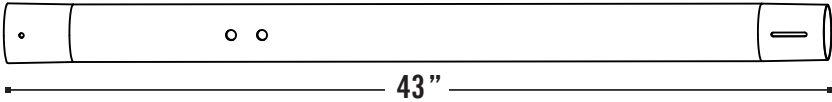

ALF (x1)
Middle Pole

*Warning Sticker applied to side not shown

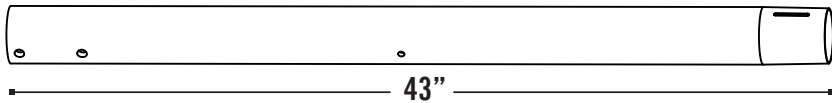

ALE (x1)
Bottom Pole



ALB (x1)
Outer Tube

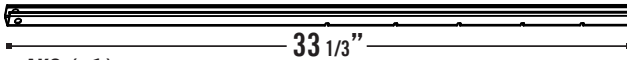

AKQ (x1)
Inner Channel

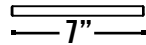

AJE (x1)
1/2" x 7" Axle

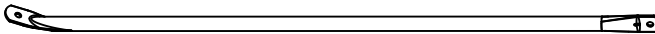

ALI (x2)
Pole Brace



AJK (x1)
Right Backboard Bracket

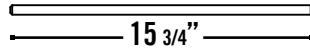

AJC (x1)
1/2" x 15 3/4" Axle

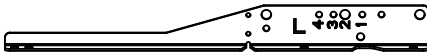

AJJ (x1)
Left Backboard Bracket

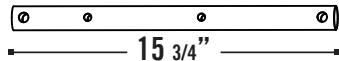

AKC (x2)
Short Extension Arm

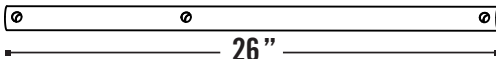

AKB (x2)
Long Extension Arm

PARTS IDENTIFIER

Parts shown at 10% of Actual Size

AKZ (x1)
Net

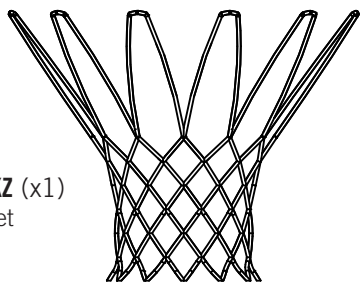

ALX (x1)
Rim

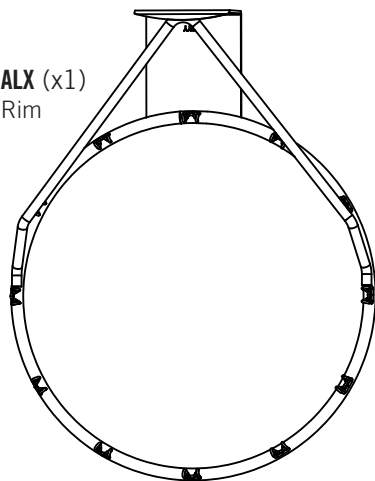

Parts shown at 5% of Actual Size

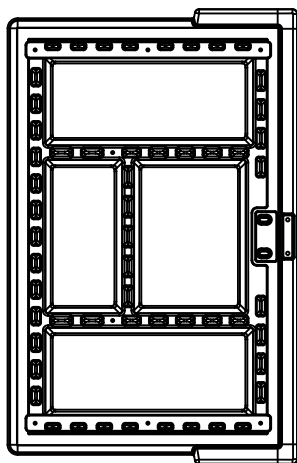

AJI (x1)
Backboard

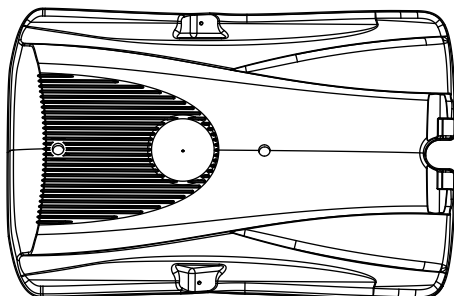

AJM (x1)
Base

Part shown at Actual Size

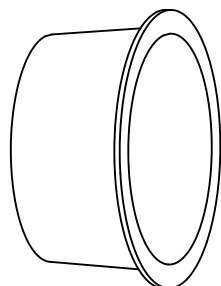

AEF (x2)
Base Plug

PARTS IDENTIFIER

Parts shown at 25% of Actual Size

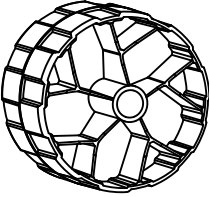

AMU (x2)
Wheel



AKL (x1)
Left Handle



AKN (x1)
Right Handle

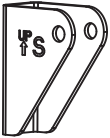

ALL (x1)
Pole Bracket



AMN (x1)
Trigger

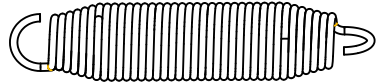

AJY (x1)
Counterbalance Spring

HARDWARE IDENTIFIER

POLE ASSEMBLY HARDWARE

Hardware shown at Actual Size

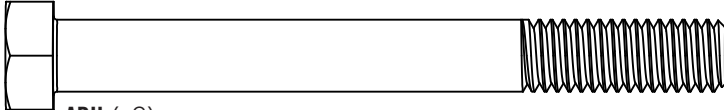

ABH (x2)
3/8" x 3 1/2" Hex Bolt

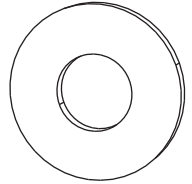

AAF (x2)
3/8" Washer



ADA (x2)
1/2" x 2.91" Spacer



ABB (x2)
3/8" Centerlock Nut



ADS (x2)
1/4" x 3/4" Screw

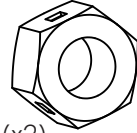
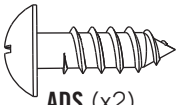
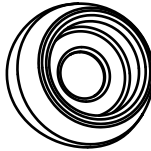

CIH (x2)
Domed Counter-sink Washer

POLE TO BASE ASSEMBLY HARDWARE

Hardware shown at Actual Size

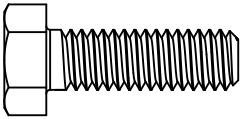

AAE (x2)
5/16" x 1" Hex Bolt

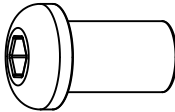

BTS (x1)
1/4" Barrel Nut

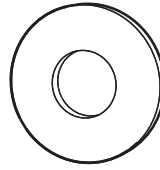

ABD (x4)
5/16" Washer

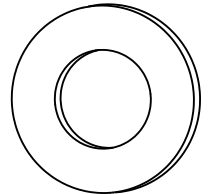

ABN (x2)
1/2" x 1/8" Spacer

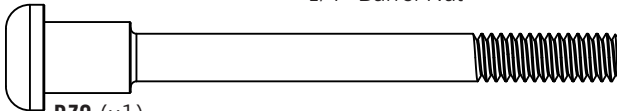

BZO (x1)
1/4" x 3" Shoulder Bolt

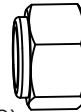

AAO (x2)
5/16" Nylock Nut

BACKBOARD TO RIM ASSEMBLY HARDWARE

Hardware shown at Actual Size

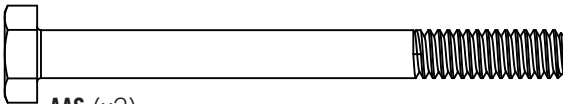

AAS (x2)
1/4" x 2 3/4" Hex Bolt

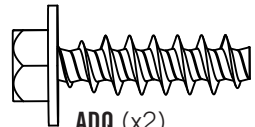

ADQ (x2)
5/16" x 1" Screw

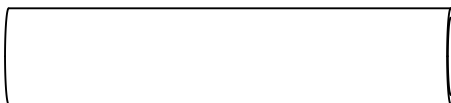

ABS (x2)
1/2" x 2 5/16" Galvanized Spacer

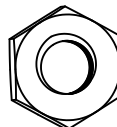

AAV (x2)
5/16" Jam Nut

HARDWARE IDENTIFIER

BACKBOARD TO RIM ASSEMBLY HARDWARE (CONTINUED)

Hardware shown at Actual Size



ABI (x2)
5/16" x 2 1/4" Tap Bolt

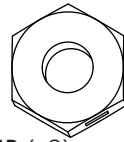

AAB (x2)
1/4" Centerlock Nut

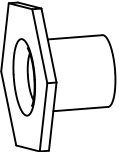

AAJ (x2)
5/16" Hex T-Nut

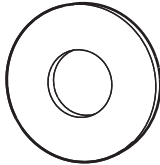

ABD (x2)
5/16" Washer

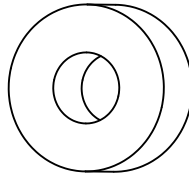

ABF (x2)
7/16" Rubber Washer



ABK (x4)
5/16" Nylock Flange Nut

Hardware shown at 25% of Actual Size



AOW (x1)
Spring Retainer Plate



AOX (x2)
Rim Support Channel



AJW (x2)
Compression Spring

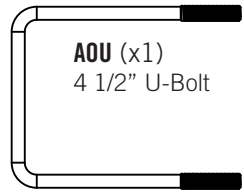

AOU (x1)
4 1/2" U-Bolt

BACKBOARD TO POLE ASSEMBLY HARDWARE

Hardware shown at Actual Size

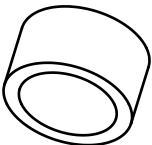

ABP (x4)
1/2" x 3/8" Clear Poly Spacer

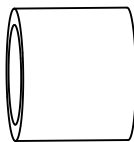

ABL (x4)
.69" x .59" Black Spacer

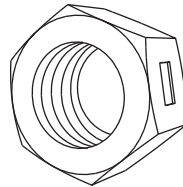

AAX (x4)
1/2" Centerlock Nut

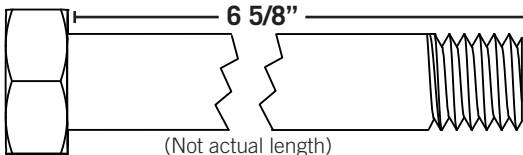

ADG (x4)
1/2" x 6 5/8" Hex Bolt

HARDWARE IDENTIFIER

HANDLE ASSEMBLY HARDWARE

Hardware shown at Actual Size

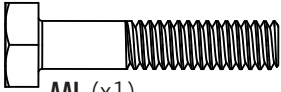

AAL (x1)
1/4" x 1 1/4" Hex Bolt

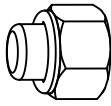

AAU (x1)
1/4" Cap Nut

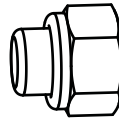

AAN (x1)
5/16" Cap Nut

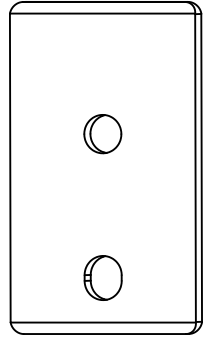

AQQ (x1)
Lock Tab

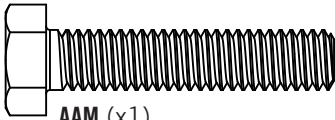

AAM (x1)
5/16" x 1 1/2" Tap Bolt



ACZ (x2)
.69" x 1.4" Spacer

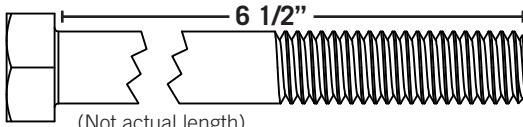

(Not actual length)
ABA (x1)
3/8" x 6 1/2" Hex Bolt



ABB (x1)
3/8" Centerlock Nut



(Not actual length)
ADG (x1)
1/2" x 6 5/8" Hex Bolt

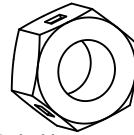
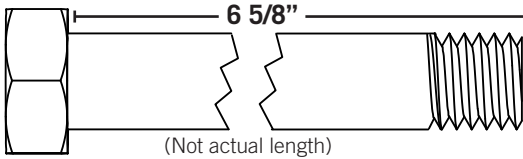
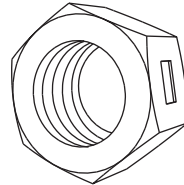

AAX (x1)
1/2" Centerlock Nut

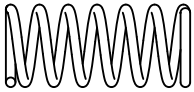

AQH (x1)
Trigger Spring



AAP (x2)
#6 x 3/8" Phillips
Pan Head Screw



ADT (x7)
#6 x 5/8" Screw

STEP 1 POLE ASSEMBLY

HARDWARE REQUIRED

Hardware shown at Actual Size

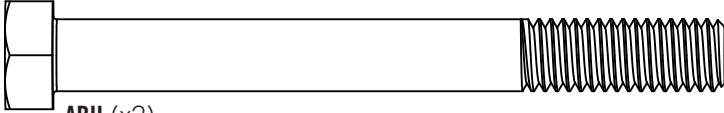

ABH (x2)
3/8" x 3 1/2" Hex Bolt

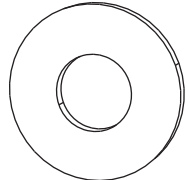

AAF (x2)
3/8" Washer



ADA (x2)
1/2" x 2.91" Spacer

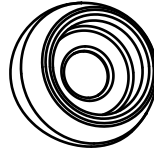

CIH (x2)
Domed Countersink Washer

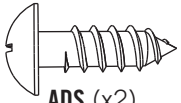

ADS (x2)
1/4" x 3/4" Screw



ABB (x2)
3/8" Centerlock Nut

PARTS REQUIRED

Parts shown at 10% of Actual Size

Part shown at 25% of Actual Size

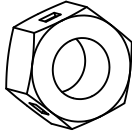
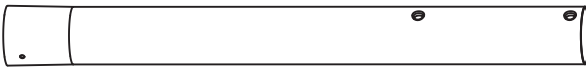

30 1/2"

ALH (x1)
Top Pole



ALL (x1)
Pole Bracket

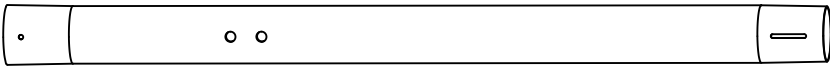

43"

ALF (x1)
Middle Pole

*Warning Sticker applied to side not shown

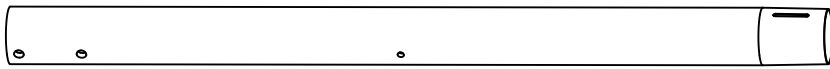

43"

ALE (x1)
Bottom Pole

TOOLS REQUIRED

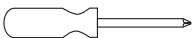

Phillips Screwdriver



9/16" Wrench (x2)

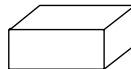

Scrap Wood



TOOLS AND HARDWARE REQUIRED FOR THIS PAGE

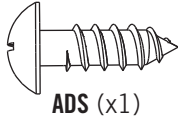

ADS (x1)

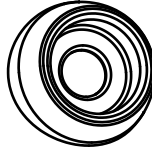

CIH (x1)

SEC

1.1

Align the hole in the **Top Pole (ALH)** with the slot in the **Middle Pole (ALF)** and slide the Top Pole over the Middle Pole. Insert a **1/4" x 3/4" Screw (ADS)** through a **Domed Countersink Washer (CIH)** and into the small hole in the Top Pole and into the slot in the Middle Pole as shown.

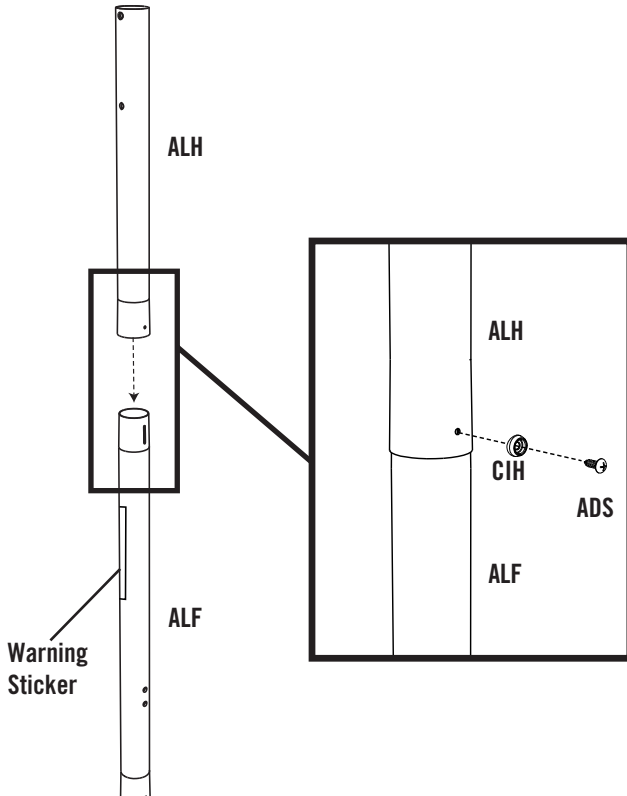

! *Note: The 1/4" x 3/4" Screw and Domed Countersink Washer should be flush with the Pole, but will spin freely once installed. Do not jam the Poles together until instructed.*



TOOLS AND HARDWARE REQUIRED FOR THIS PAGE

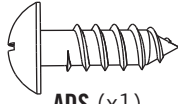

ADS (x1)



CIH (x1)

SEC

1.2

Align the hole in the **Middle Pole (ALF)** with the slot in the **Bottom Pole (ALE)** and slide the Middle Pole over the Bottom Pole. Insert a **1/4" x 3/4" Screw (ADS)** through a **Domed Countersink Washer (CIH)** and into the small hole in the Middle Pole and into the slot in the Bottom Pole as shown.

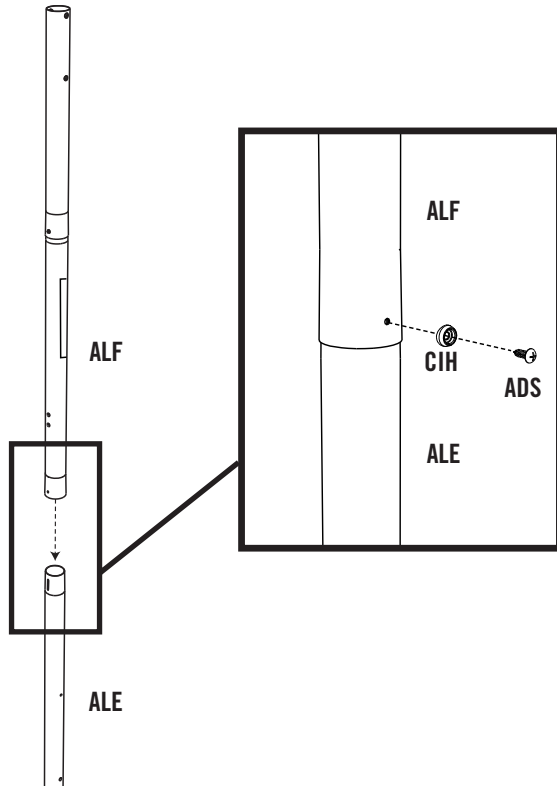

Note: The 1/4" x 3/4" Screw and Domed Countersink Washer should be flush with the Pole, but will spin freely once installed. Do not jam the Poles together until instructed.



TOOLS AND HARDWARE REQUIRED FOR THIS PAGE

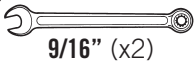

9/16" (x2)



ABB (x2)

ADA (x2)



ABH (x2)

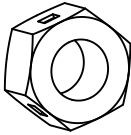
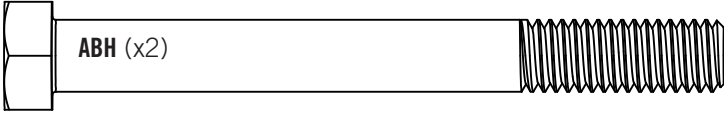
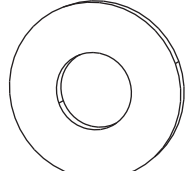

AAF (x2)

SEC

1.3

Insert the **3/8" x 3 1/2" Hex Bolts (ABH)** with the **3/8" Flat Washers (AAF)** into the **Middle Pole (ALF)** as shown. Then slide the **1/2" x 2.91" Spacers (ADA)** onto the Hex Bolts. Place the **Pole Bracket (ALL)** onto the 3/8" x 3 1/2" Hex Bolts, and attach it to the Middle Pole with the hardware shown.

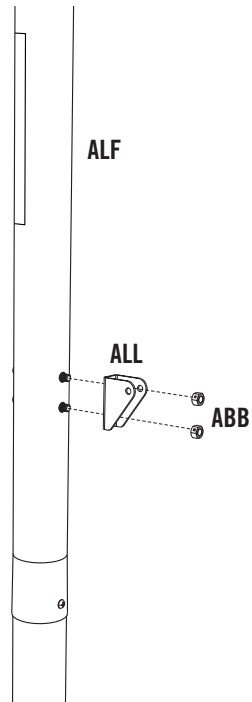
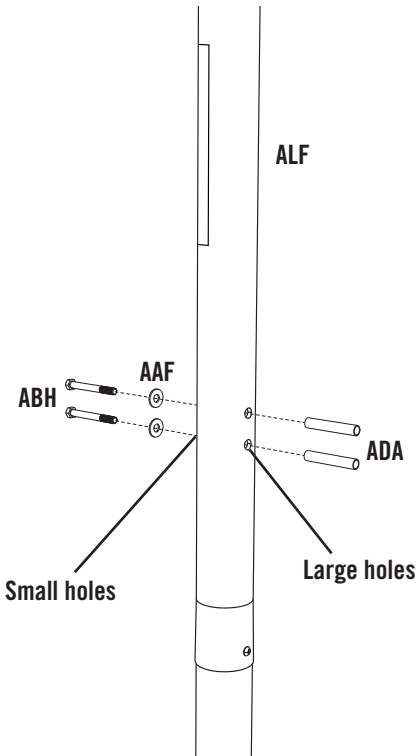



TOOLS AND HARDWARE REQUIRED FOR THIS PAGE

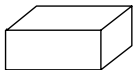

Scrap Wood

NO HARDWARE REQUIRED FOR THIS PAGE

SEC

1.4

ATTENTION: THIS STEP CANNOT BE REVERSED!

In order to seat the Poles, strike each end of the Pole very hard five to six times on a piece of scrap wood or cardboard. This must be done even if the Poles cover the slots before seating has occurred.

If the **Top and Middle Poles (ALH & ALF)** do not completely cover the slots on the **Middle and Bottom Poles (ALF & ALE)** after seating, **DO NOT COMPLETE ASSEMBLY**. Call our Customer Service Department.



WARNING

The Poles must be seated together! Even if the Poles cover the slots before seating, they must be struck on a hard surface five to six times! Failure to seat the Poles correctly could allow the Poles to separate during use, which could lead to serious personal injuries or property damage.



Note: Do not hit your feet with the Pole sections, as serious injury could occur.

SEC 2 POLE TO BASE ASSEMBLY

HARDWARE REQUIRED

Hardware shown at Actual Size

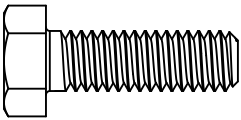

AAE (x2)
5/16" x 1" Hex Bolt

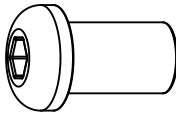

BTS (x1)
1/4" Barrel Nut

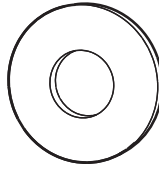

ABD (x4)
5/16" Washer

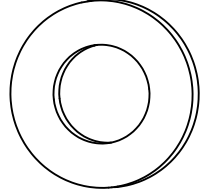

ABN (x2)
1/2" x 1/8" Spacer

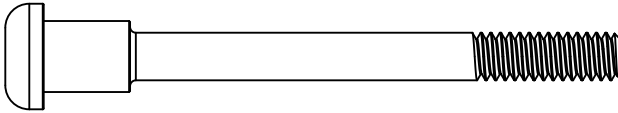

BZO (x1)
1/4" x 3" Shoulder Bolt

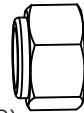

AAO (x2)
5/16" Nylock Nut

PARTS REQUIRED

Part shown at 5% of Actual Size

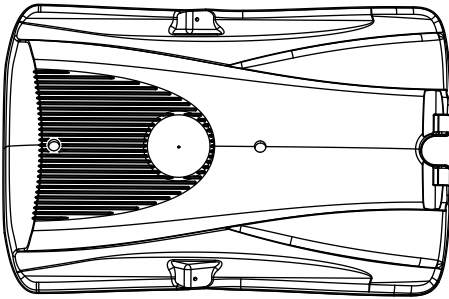

AJM (x1)
Base

Part shown at 25% of Actual Size

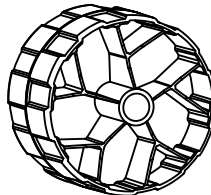

AMU (x2)
Wheel

Parts shown at 10% of Actual Size

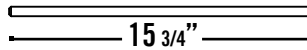

AJC (x1)
1/2" x 15 3/4" Axle

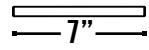

AJE (x1)
1/2" x 7" Axle

ALI (x2)
Pole Brace

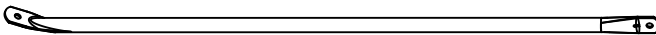

TOOLS REQUIRED

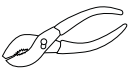

Pliers



1/2" Wrench (x2)



CCL-3/16" Allen Wrench
(x2, included)



TOOLS AND HARDWARE REQUIRED FOR THIS PAGE

NO TOOLS REQUIRED FOR THIS PAGE

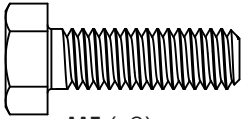

AAE (x2)

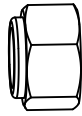

AAO (x2)

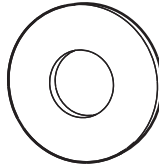

ABD (x4)

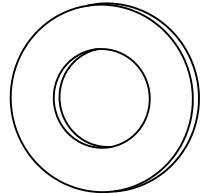

ABN (x2)

SEC

2.1

Attach the flattened end of the **Pole Brace (ALI)** to the **Base (AJM)** with the hardware shown. **Only finger tighten the hardware for now.**

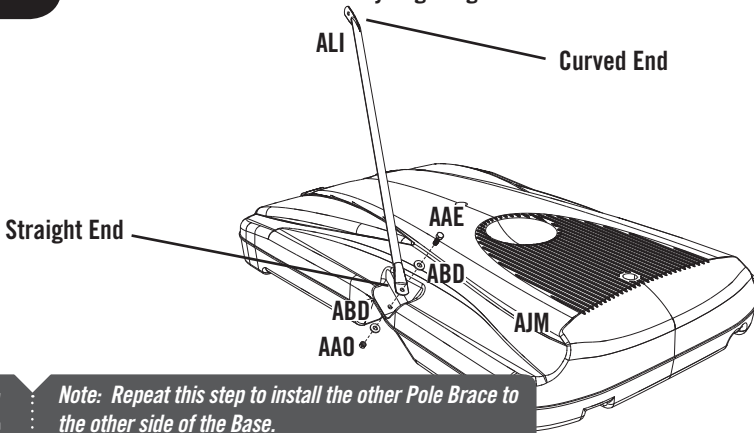

Note: Repeat this step to install the other Pole Brace to the other side of the Base.

SEC

2.2

Slide the $\frac{1}{2}$ " x $15 \frac{3}{4}$ " Axle (AJC) through the **Wheels (AMU)** and the holes at the end of the **Bottom Pole (ALE)** as shown. Slide the $\frac{1}{2}$ " x 7" Axle (AJE) through the second set of holes near the end of the Bottom Pole as shown. Then slide two $\frac{1}{2}$ " x $\frac{1}{8}$ " Spacers (ABN) onto the $\frac{1}{2}$ " x $15 \frac{3}{4}$ " Axle and position them against the **Wheels**.

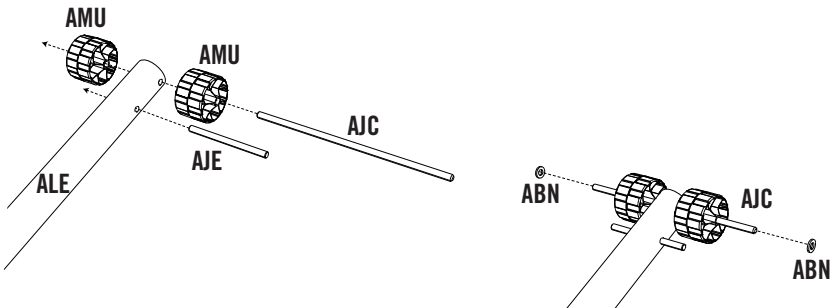



TOOLS AND HARDWARE REQUIRED FOR THIS PAGE

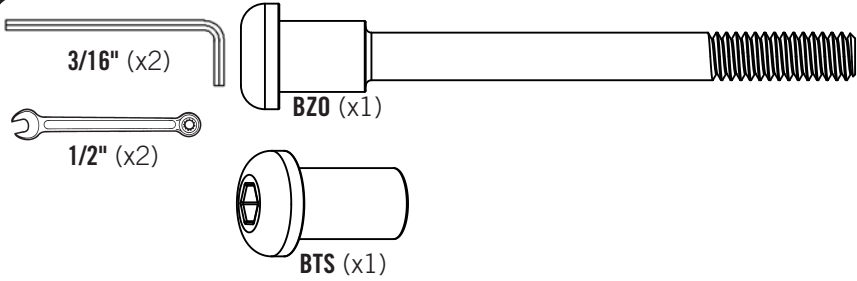

SEC

2.3

Place the Pole assembly on the ground with the Warning Sticker on the **Middle Pole (ALF)** facing down. Position the **1/2" x 15 3/4" Axle (AJC)** under the bottom slots of the **Base (AJM)** as shown, and step onto the Base so the Axle snaps into the slots. Then rotate the Pole assembly upward so that the **1/2" x 7" Axle (AJE)** snaps into the upper slots of the Base as shown.

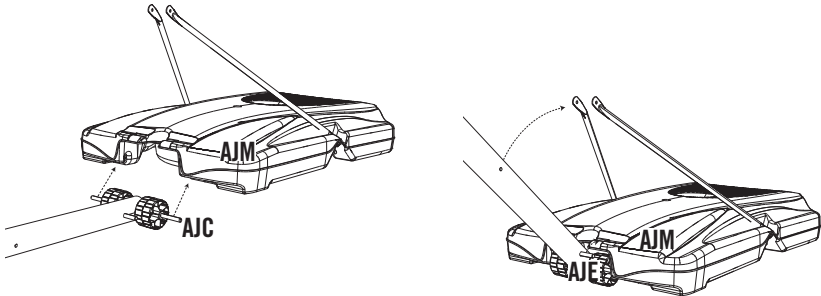

SEC

2.4

Attach the **Pole Braces (ALI)** to the **Bottom Pole (ALE)** with the hardware shown, and **tighten all Pole to Base assembly hardware**.

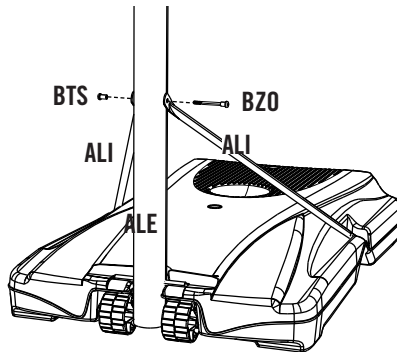

Note: Tip the system forward so the Pole rests on the ground. Do not stand the system up until it is filled with either sand or water later in the assembly.

SEC 3 BACKBOARD TO RIM ASSEMBLY

HARDWARE REQUIRED

Hardware shown at Actual Size

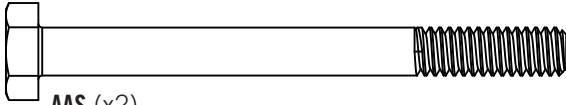

AAS (x2)
1/4" x 2 3/4" Hex Bolt

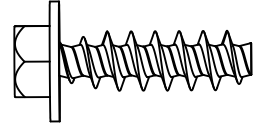

ADQ (x2)
5/16" x 1" Screw



ABI (x2)
5/16" x 2 1/4" Tap Bolt



AAB (x2)
1/4" Centerlock Nut



AAV (x2)
5/16" Jam Nut



ABS (x2)
1/2" x 2 5/16" Galvanized Spacer

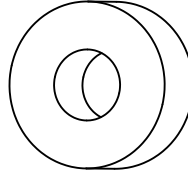

ABF (x2)
7/16" Rubber Washer

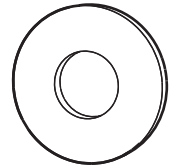

ABD (x2)
5/16" Washer



ABK (x4)
5/16" Nylock Flange Nut

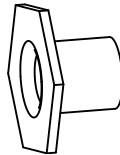

AAJ (x2)
5/16" Hex T-Nut

Hardware shown at 25% of Actual Size



AOW (x1)
Spring Retainer Plate



AJW (x2)
Compression Spring

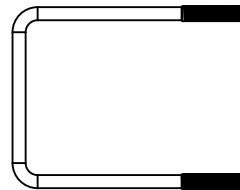

AOU (x1)
4 1/2" U-Bolt

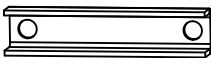

AOX (x1)
Rim Support Channel

SEC 3 BACKBOARD TO RIM ASSEMBLY

PARTS REQUIRED

Parts shown at 10% of Actual Size

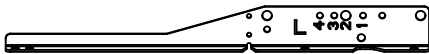

AJJ (x1)

Left Backboard Bracket



AJK (x1)

Right Backboard Bracket

ALX (x1)
Rim

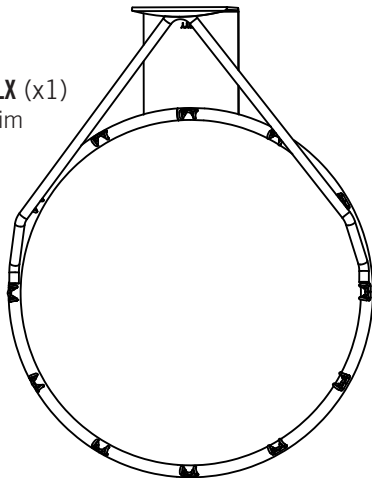

Part shown at 5% of Actual Size

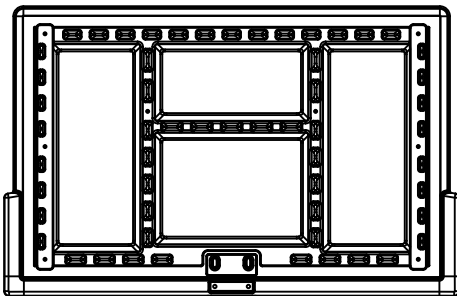

AJI (x1)

Backboard

TOOLS REQUIRED



Pliers



1/2" Wrench



7/16" Wrench (x2)



TOOLS AND HARDWARE REQUIRED FOR THIS PAGE



7/16" (x2)

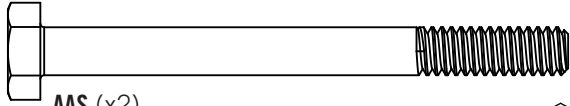

AAS (x2)

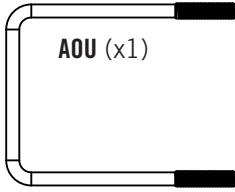

AOU (x1)

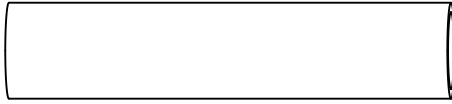

ABS (x2)

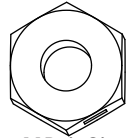

AAB (x2)

(Not to scale)

SEC

3.1

Slide the 4 1/2" U-Bolt (AOU) through the **Left and Right Backboard Brackets (AJJ & AJK)**. The U-Bolt must rest in the notches of the Backboard Brackets as shown.

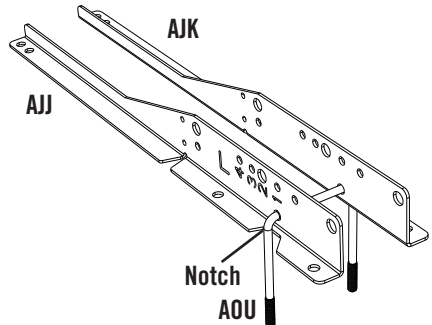
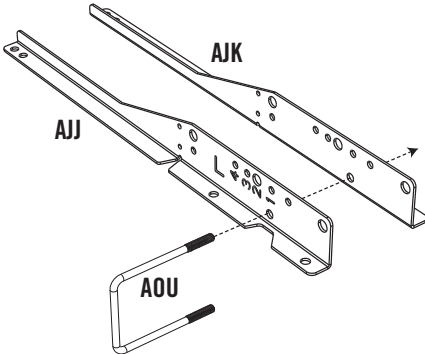

SEC

3.2

Connect the Backboard Brackets together using two 1/4" x 2 3/4" Hex Bolts (AAS), two 1/2" x 2 5/16" Galvanized Spacers (ABS), and two 1/4" Centerlock Nuts (AAB).

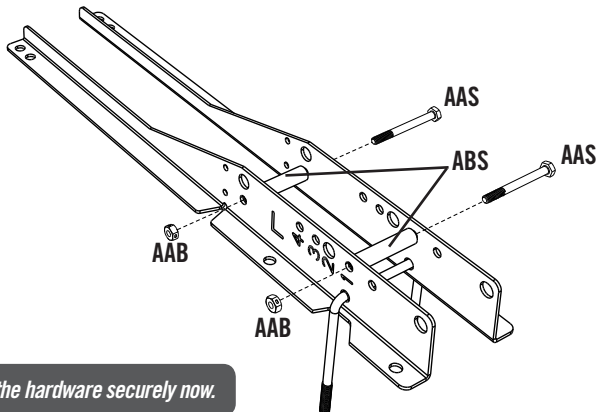

Note: Tighten the hardware securely now.



TOOLS AND HARDWARE REQUIRED FOR THIS PAGE

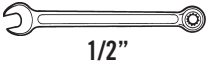

1/2"

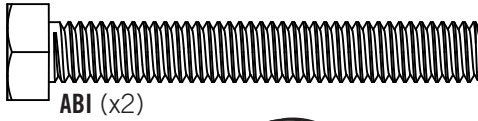

ABI (x2)

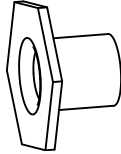

AAJ (x2)

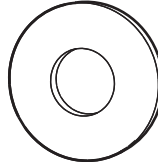

ABD (x2)

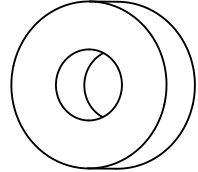

ABF (x2)

SEC

3.3

Insert two **5/16" x 2 1/4" Tap Bolts (ABI)** with the **5/16" Washers (ABD)** and the **7/16" Rubber Washers (ABF)** through the bottom holes in the back of the **Rim (ALX)** as shown, and secure the hardware with two **5/16" Hex T-Nuts (AAJ)**.

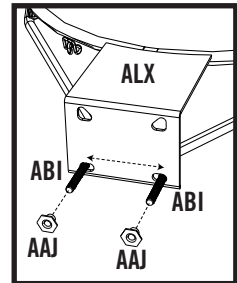
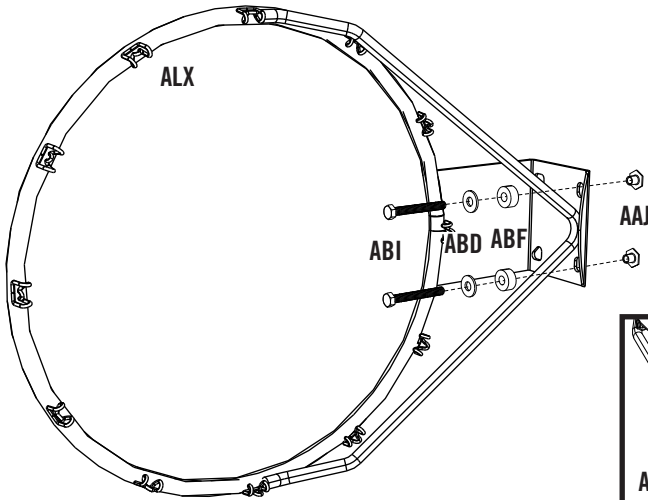

Note: Make sure that the 5/16" x 2 1/4" Tap Bolts are positioned on the outside edge of the holes as shown.

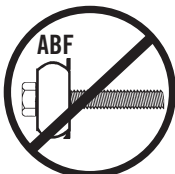

Incorrect

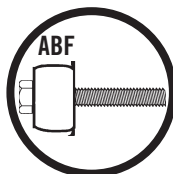

Correct



Note: Do not overtighten the hardware so that the 7/16" Rubber Washers bulge outward as shown.



TOOLS AND HARDWARE REQUIRED FOR THIS PAGE

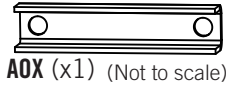
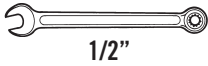

SEC

3.4

Place the **Rim Support Channel (AOX)** in the recess on the backside of the **Backboard (AJI)** so that the flat side with holes is positioned up against the Backboard as shown. Then insert the **4 1/2" U-Bolt (AOU)** through the upper holes on the backside of the Backboard as shown.

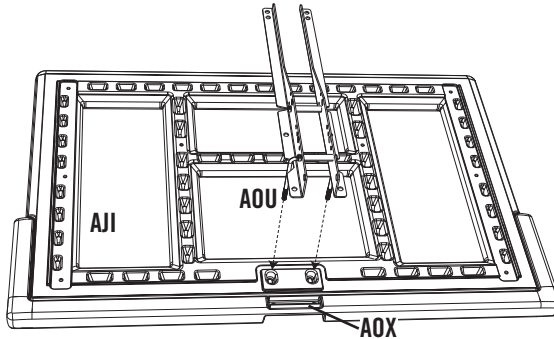

SEC

3.5

Connect the **Rim (ALX)** to the **Backboard (AJI)** with the hardware shown. Thread the **5/16" Jam Nuts (AAV)** all the way down on the **4 1/2" U-Bolt (AOU)**. On the underside of the Backboard, secure the **5/16" Nylock Flange Nuts (ABK)** onto the **5/16" x 2 1/4" Tap Bolts (ABI)**.

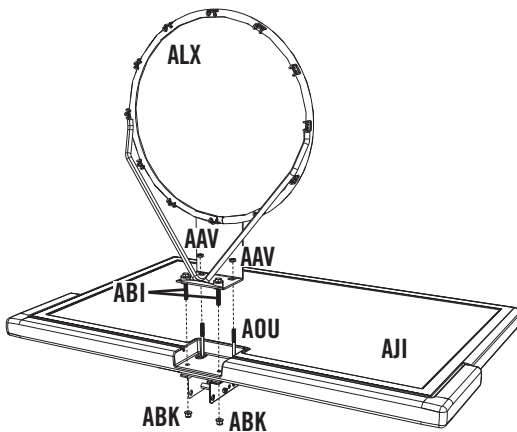



TOOLS AND HARDWARE REQUIRED FOR THIS PAGE

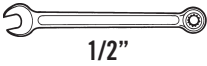

1/2"

AOW (x1)



(Not to scale)

AJW (x2)



(Not to scale)



ABK (x2)

SEC

3.6

Slide the **Compression Springs (AJW)** onto the **4 1/2" U-Bolt (AOU)**, and place the **Spring Retainer Plate (AOW)** over the Compression Springs. Tighten the **5/16" Nylock Flange Nuts (ABK)** until the **Rim (ALX)** does not wobble to complete this step.

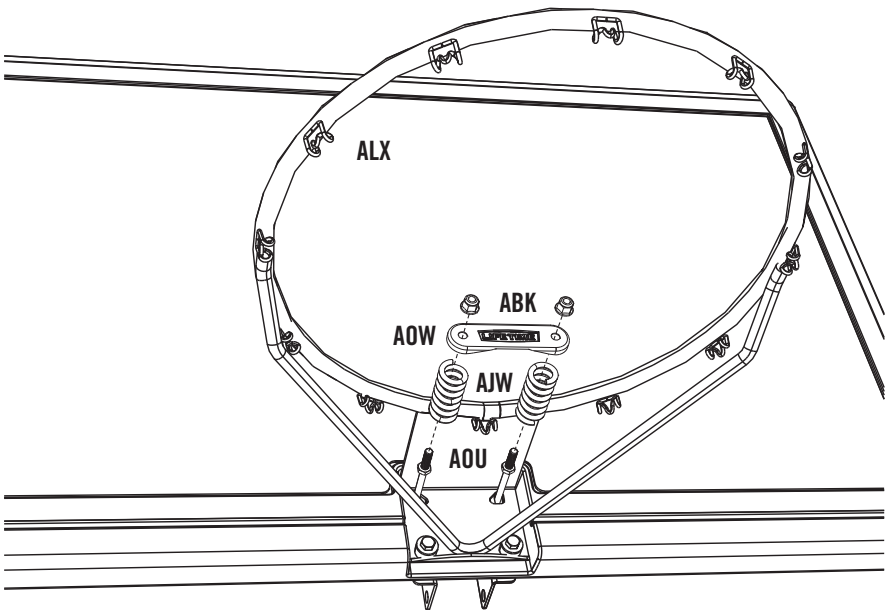

Note: DO NOT COMPLETELY TIGHTEN THE 5/16" NYLOCK FLANGE NUTS IN THIS STEP! Only tighten the Nuts until the Rim does not wobble. Tightening the Nuts will adjust the Rim tension.



TOOLS AND HARDWARE REQUIRED FOR THIS PAGE



1/2"

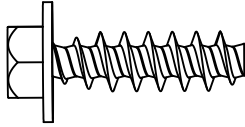

ADQ (x2)

SEC

3.7

Bend the **Left and Right Backboard Brackets (AJJ & AJK)** outward by hand and position the holes in the Backboard Brackets over the holes in the **Backboard (AJI)**. Then securely fasten the Backboard Brackets to the Backboard with the hardware shown.

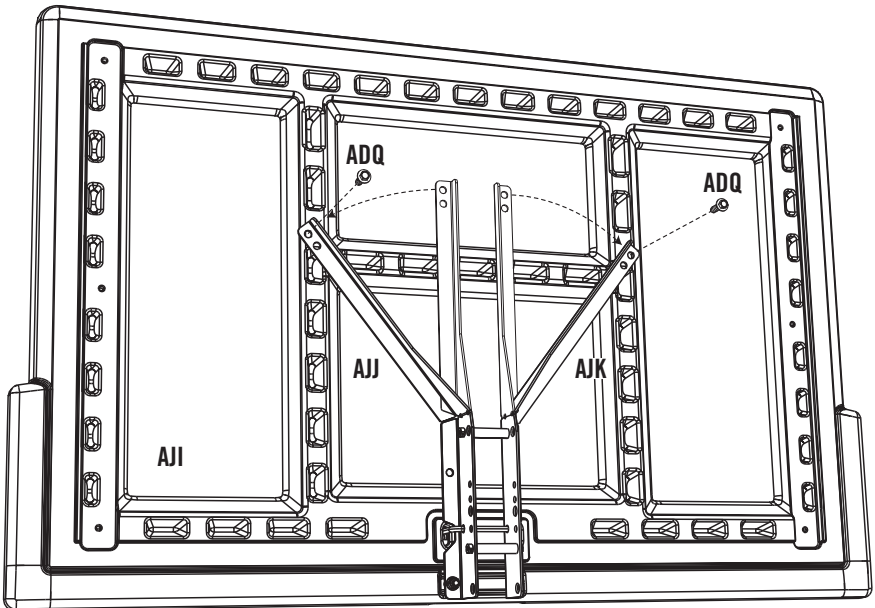

SEC 4 BACKBOARD TO POLE ASSEMBLY

HARDWARE REQUIRED

Hardware shown at Actual Size

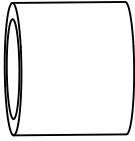

ABL (x4)
.69" x .59" Black Spacer

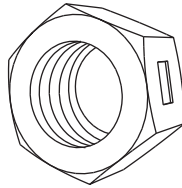

AAX (x4)
1/2" Centerlock Nut

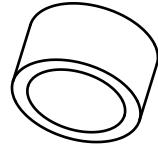

ABP (x4)
1/2" x 3/8" Poly Spacer

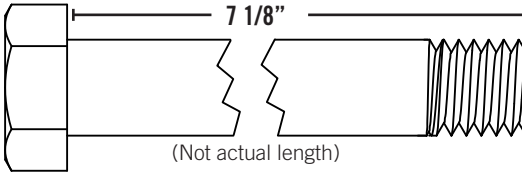

AAD (x4)
1/2" x 7 1/8" Hex Bolt

PARTS REQUIRED

Parts shown at 10% of Actual Size

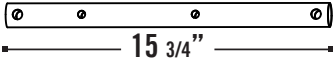

AKC (x2)
Short Extension Arm

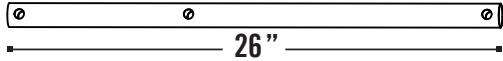

AKB (x2)
Long Extension Arm

Parts shown at 25% of Actual Size

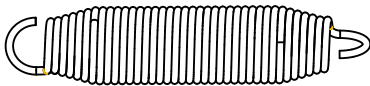

AJY (x1)
Counterbalance Spring

TOOLS REQUIRED



3/4" Wrench (x2)



7/16" Wrench (x2)



Rubber Mallet



TOOLS AND HARDWARE REQUIRED FOR THIS PAGE

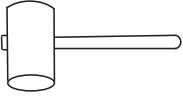

7/16" (x2)

NO HARDWARE REQUIRED FOR THIS PAGE

SEC

4.1

Place one end of the **Counterbalance Spring (AJY)** over the lower **1/2" x 2 5/16" Galvanized Spacer (ABS)** as shown.

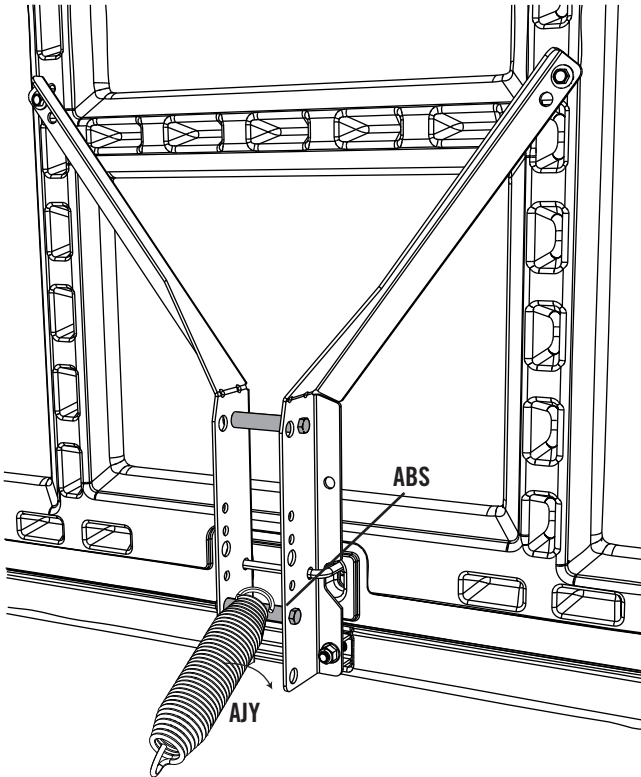

! *Note: It may be necessary to use a Rubber Mallet to snap the Counterbalance Spring into place. If the Rubber Mallet does not work, undo the hardware in the image that has been shaded gray. Slide the Counterbalance Spring over the Spacer after it has been detached. Then replace and re-secure the hardware.*



TOOLS AND HARDWARE REQUIRED FOR THIS PAGE

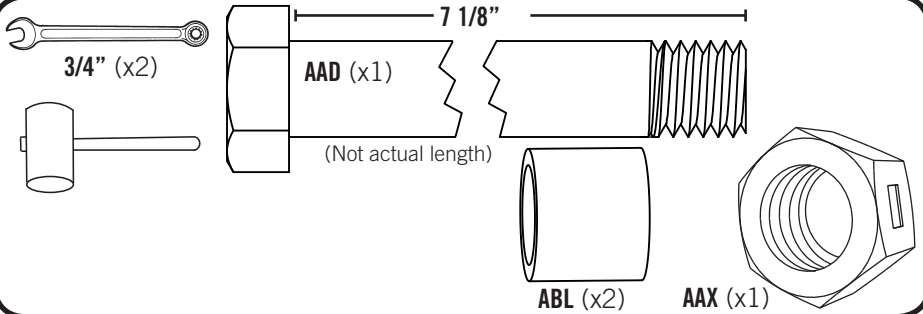

SEC

4.2

Secure the ends of the **Short Extension Arms (AKC)** that have the holes that are further apart from each other to the Backboard Brackets in the location shown with the hardware indicated.

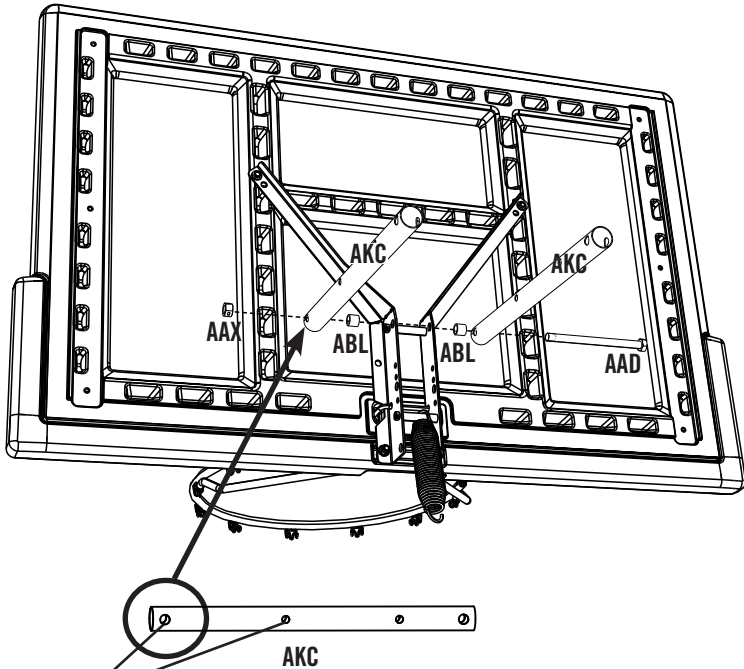

These two holes are further apart than the other two. They go nearest the Backboard.



Note: Tighten the 1/2" Centerlock Nut (AAX) until it is flush with the end of the Bolt.



TOOLS AND HARDWARE REQUIRED FOR THIS PAGE

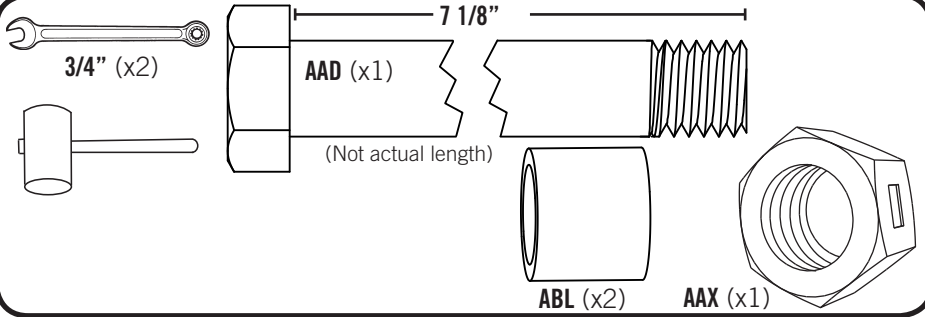

SEC

4.3

Secure the ends of the **Long Extension Arms (AKB)** that only have one hole to the Backboard Brackets in the location shown with the hardware indicated.

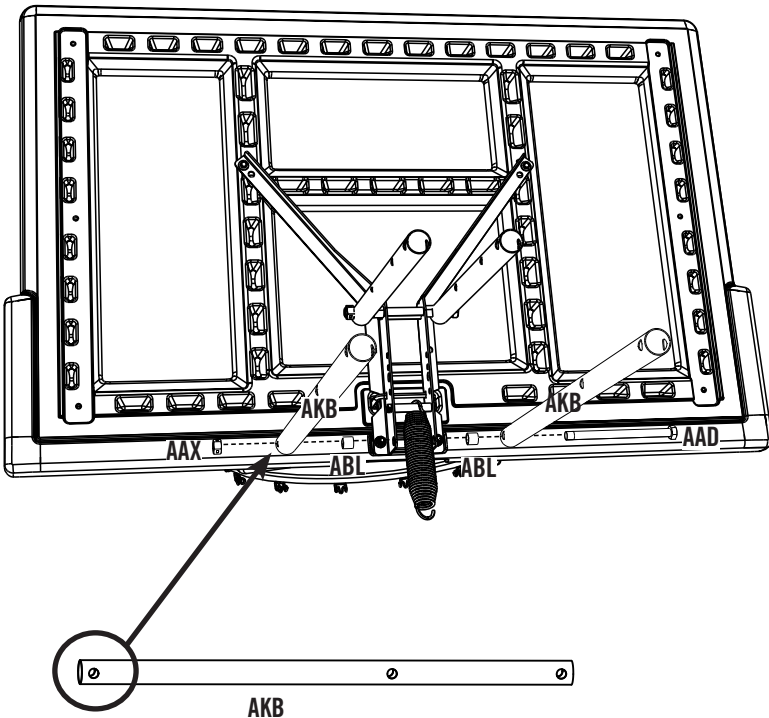

Note: Tighten the 1/2" Centerlock Nut (AAX) until it is flush with the end of the Bolt.



TOOLS AND HARDWARE REQUIRED FOR THIS PAGE

3/4" (x2)

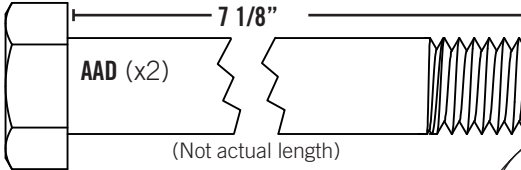
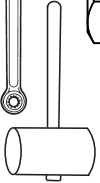

(Not actual length)

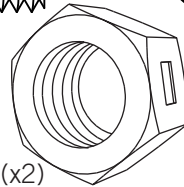

AAX (x2)

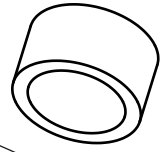

ABP (x4)

SEC

4.4



CAUTION: HAVE ONE ADULT HOLD THE BACKBOARD IN PLACE UNTIL ASSEMBLY HAS BEEN COMPLETED!



Lay the Backboard and Rim assembly next to the Pole assembly. Rest the Rim on cardboard to prevent scratching. Then secure the **Short and Long Extension Arms (AKC & AKB)** to the **Top Pole (ALH)** with the hardware shown.

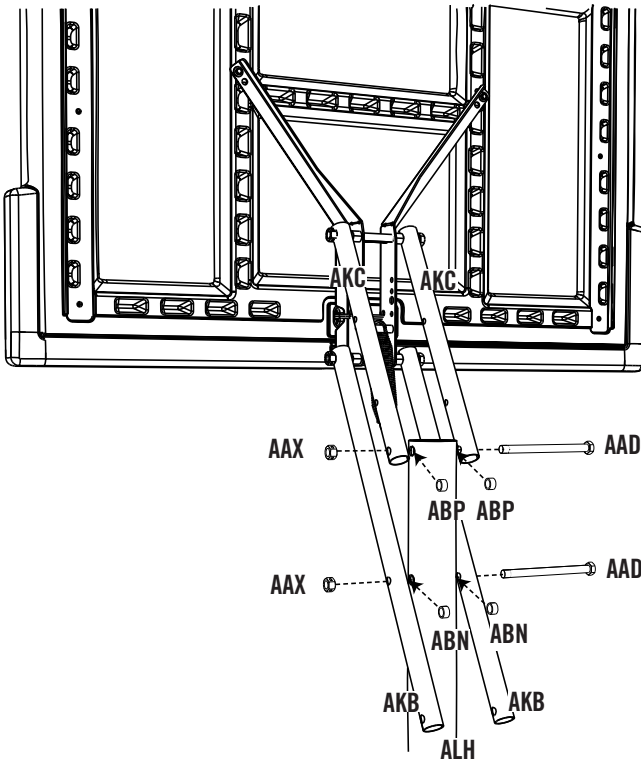

Note: Tighten the 1/2" Centerlock Nuts (AAX) until they are flush with the ends of the Bolts.

SEC 5 HANDLE ASSEMBLY

HARDWARE REQUIRED

Hardware shown at Actual Size

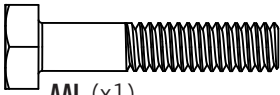

AAL (x1)
1/4" x 1 1/4" Hex Bolt

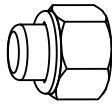

AAU (x1)
1/4" Cap Nut

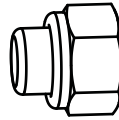

AAN (x1)
5/16" Cap Nut

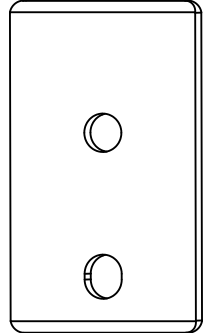

AQQ (x1)
Lock Tab

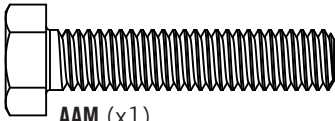

AAM (x1)
5/16" x 1 1/2" Tap Bolt

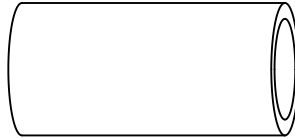

ACZ (x2)
.69" x 1.4" Spacer

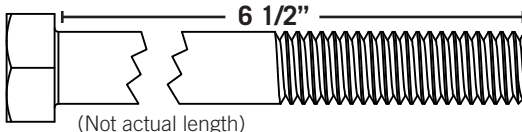

ABA (x1)
3/8" x 6 1/2" Hex Bolt



ABB (x1)
3/8" Centerlock Nut



ADG (x1)
1/2" x 6 5/8" Hex Bolt

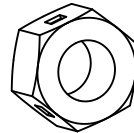
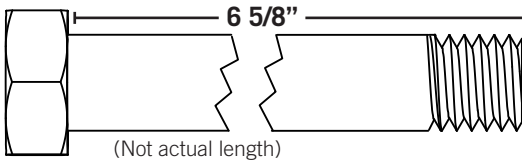
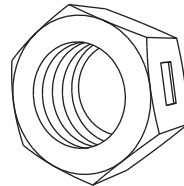

AAX (x1)
1/2" Centerlock Nut



AQH (x1)
Trigger Spring



AAP (x2)
#6 x 3/8" Phillips
Pan Head Screw



ADT (x7)
#6 x 5/8" Screw

SEC 5 HANDLE ASSEMBLY

PARTS REQUIRED

Parts shown at 10% of Actual Size



ALB (x1)
Outer Tube

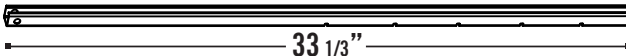

AKQ (x1)
Inner Channel

Parts shown at 25% of Actual Size

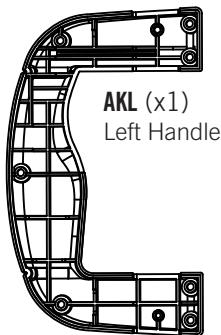

AMN (x1)
Trigger

TOOLS REQUIRED

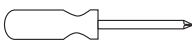

Phillips Screwdriver



7/16" Wrench (x2)



1/2" Wrench (x2)



3/4" Wrench (x2)



9/16" Wrench (x2)



TOOLS AND HARDWARE REQUIRED FOR THIS PAGE



AAP (x2)

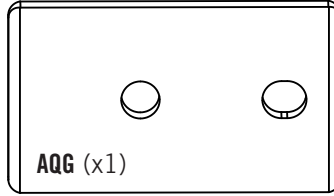

SEC

5.1

Secure the **Lock Tab (AQG)** to the **Trigger (AMN)** with the hardware shown.

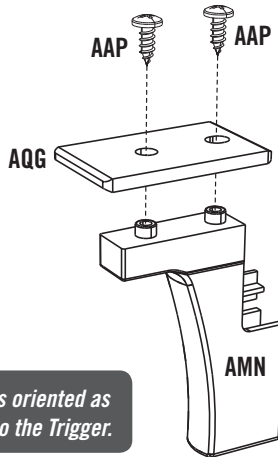

Note: Make sure the Lock Tab is oriented as shown when attaching the Tab to the Trigger.

SEC

5.2

Place the **Right Handle (AKN)** onto the **Outer Tube (ALB)** so that the notch of the Outer Tube fits within the Handle as shown.

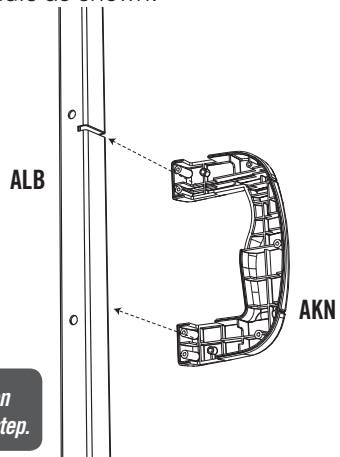

Note: Make sure that the Inner Channel (AKQ) has been removed from the Outer Tube before performing this step.



TOOLS AND HARDWARE REQUIRED FOR THIS PAGE



ADT (x7)



AQH (x1)

SEC

5.3

Place the **Trigger Spring (AQH)** onto the **Trigger (AMN)** as shown. Then place the Trigger inside the **Right Handle (AKN)** so that the **Lock Tab (AQG)** fits into the slot on the **Outer Tube (ALB)** as shown.

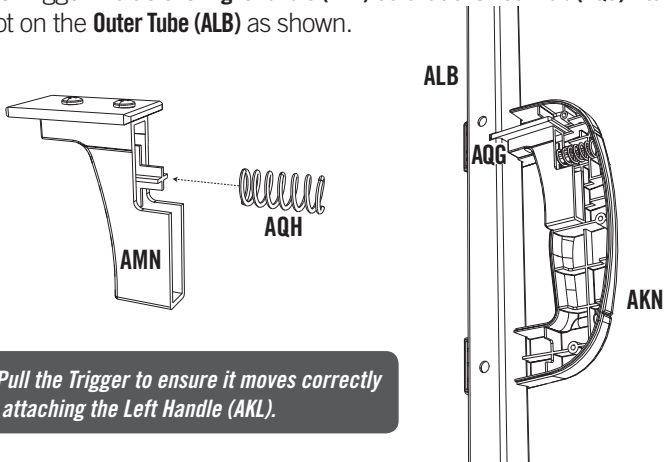

Note: Pull the Trigger to ensure it moves correctly before attaching the Left Handle (AKL).

SEC

5.4

Place the **Left Handle (AKL)** over the **Right Handle (AKN)** as shown, and attach the Handles to the **Outer Tube (ALB)** with the hardware shown.

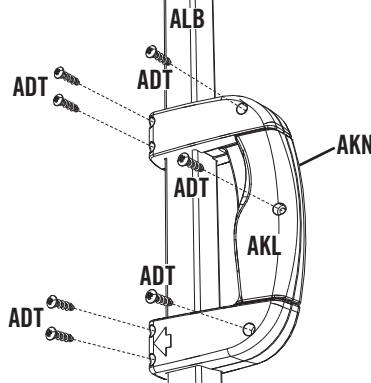

Note: To prevent stripping the holes in the Handles, do not overtighten the #6 x 5/8" Screws (ADT).



TOOLS AND HARDWARE REQUIRED FOR THIS PAGE



7/16" (x2)

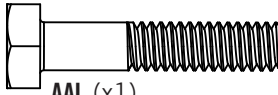

AAL (x1)

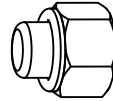

AAU (x1)

SEC

5.5

Insert the 1/4" x 1 1/4" Hex Bolt (AAL) through the holes indicated on the Outer Tube (ALB).
Secure the 1/4" x 1 1/4" Hex Bolt to the Outer Tube with the 1/4" Cap Nut (AAU).

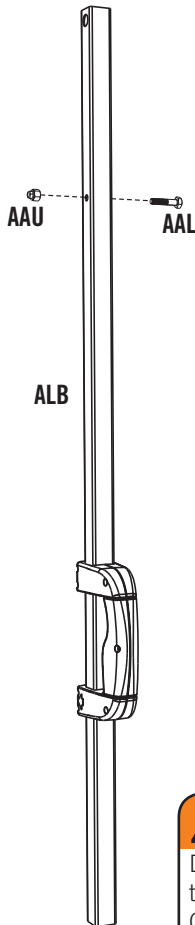

WARNING

Do not overtighten the Cap Nut. If the end of the Bolt breaks through the plastic cap, call our Customer Service Department. Exposed threads on the end of the Bolt may cause serious injuries.



TOOLS AND HARDWARE REQUIRED FOR THIS PAGE



1/2" (x2)

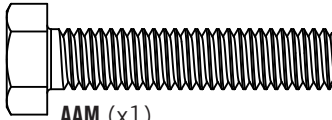

AAM (x1)

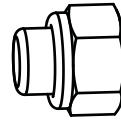

AAN (x1)

SEC

5.6

While depressing the **Trigger (AMN)**, insert the notched end of the **Inner Channel (AKQ)** into the **Outer Tube (ALB)**. Continue to insert the Inner Channel into the Outer Tube until the Trigger clicks into the first slot. Then release the Trigger.

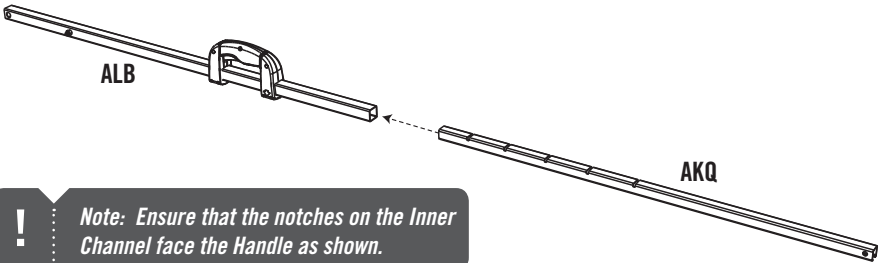

Note: Ensure that the notches on the Inner Channel face the Handle as shown.

SEC

5.7

Attach the end of the **Inner Channel (AKQ)** to the **Pole Bracket (ALL)** with the hardware shown.

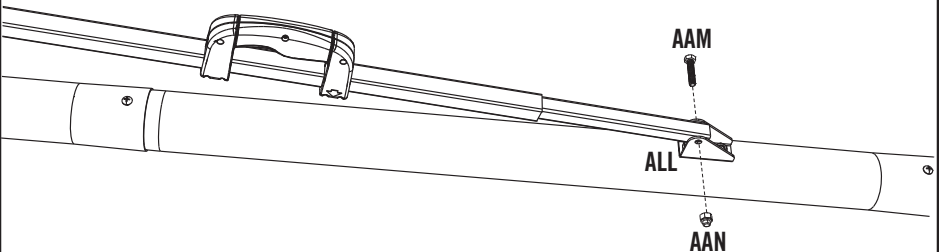

WARNING

Do not overtighten the Cap Nut.



TOOLS AND HARDWARE REQUIRED FOR THIS PAGE



3/4" (x2)

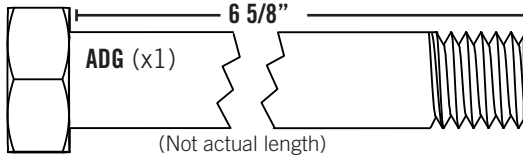

ACZ (x2)

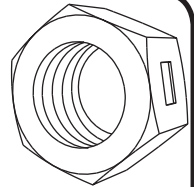
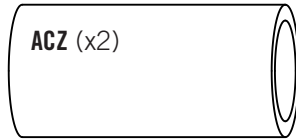

AAX (x1)

SEC

5.8

Secure the end of the **Outer Tube (ALB)** to the **Long Extension Arms (AKB)** with the hardware shown.

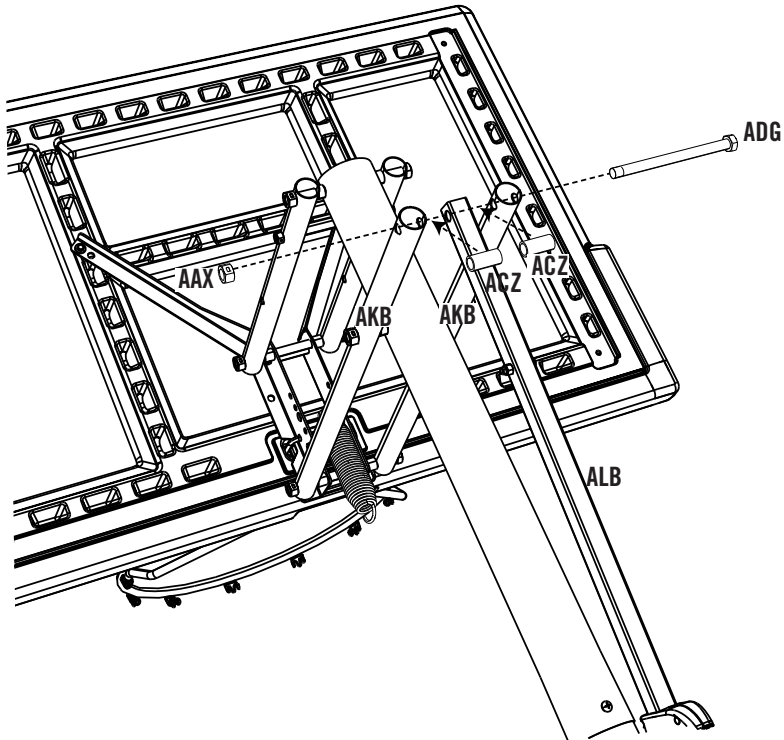

Note: Tighten the 1/2" Centerlock Nut (AAX) until it is flush with the end of the Bolt.



TOOLS AND HARDWARE REQUIRED FOR THIS PAGE



9/16" (x2)

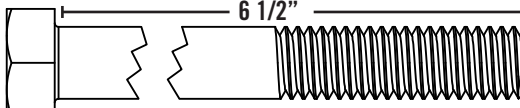

(Not actual length)

ABA (x1)



ABB (x1)

SEC

5.9

Insert the 3/8" x 6 1/2" Hex Bolt (ABA) through the holes in the **Short Extension Arms (AKC)** that are closest to the Pole. Secure the 3/8" x 6 1/2" Hex Bolt to the Short Extension Arms with the 3/8" Centerlock Nut (ABB).

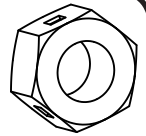
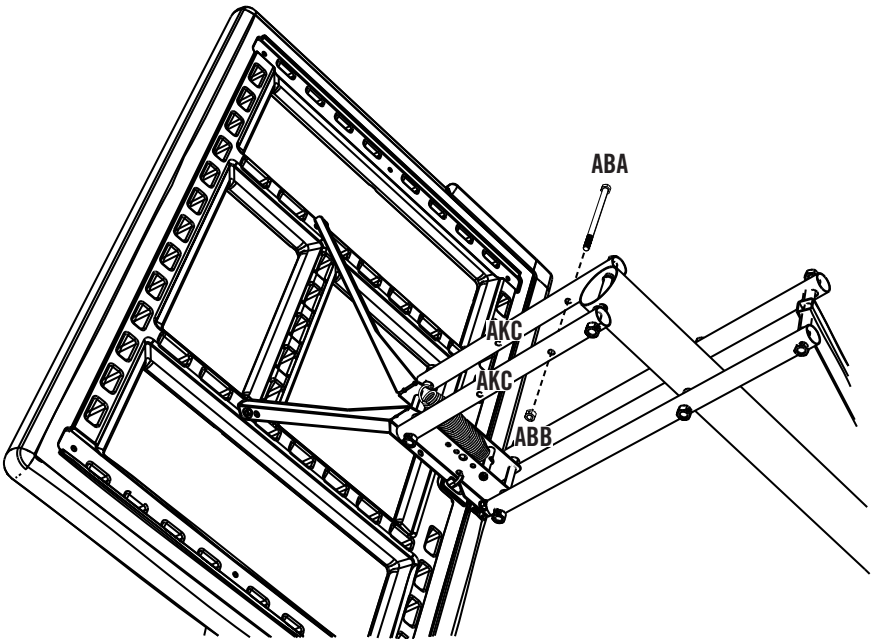

Note: Tighten the 3/8" Centerlock Nut until it is flush with the end of the Bolt.



TOOLS AND HARDWARE REQUIRED FOR THIS PAGE



Wrench

NO HARDWARE REQUIRED FOR THIS PAGE

SEC

5.10

Using the closed end of a Wrench, stretch the **Counterbalance Spring (AJY)** up and over the **3/8" x 6 1/2" Hex Bolt (ABA)** as shown.

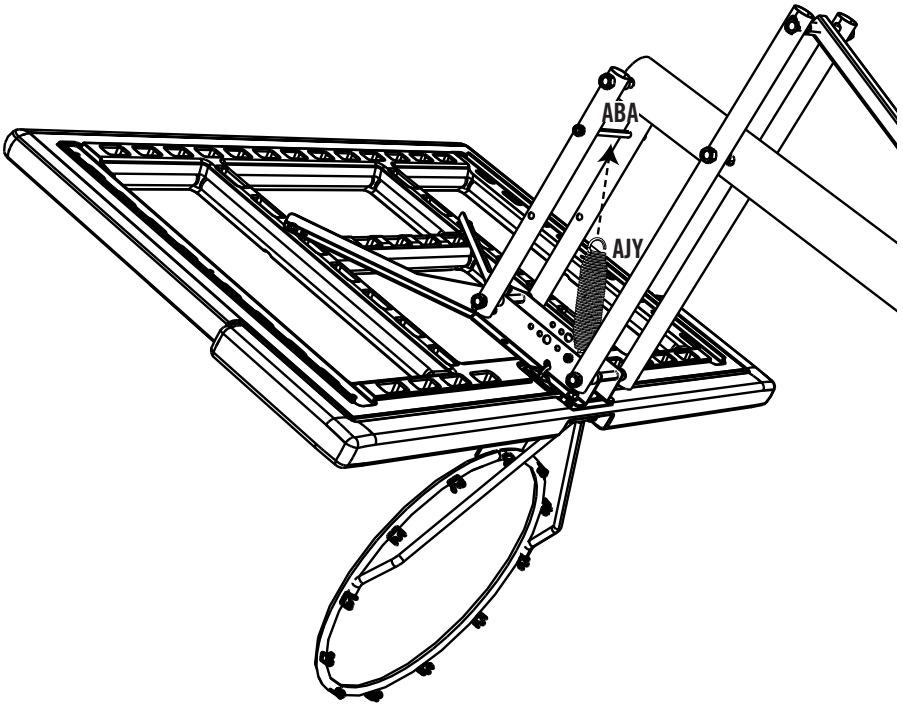

Note: Make sure all hardware has been securely tightened before moving to the next section.

SEC 6 FINAL ASSEMBLY

HARDWARE REQUIRED

NO HARDWARE REQUIRED FOR THIS SECTION

PARTS REQUIRED

Part shown at 10% of Actual Size

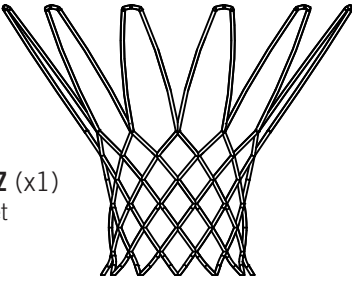

AKZ (x1)
Net

Part shown at Actual Size

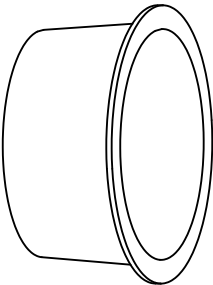

AEF (x2)
Base Plug

TOOLS REQUIRED



Funnel



Sand
(362 lb)

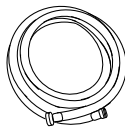

Water Hose



TOOLS AND HARDWARE REQUIRED FOR THIS PAGE



(362 lb)

NO HARDWARE REQUIRED FOR THIS PAGE

Two adults are required to complete assembly. To prevent serious injuries, the Pole should be held down by one adult at all times while the Base is being filled.

SEC

6.1

OPTION A: FILLING WITH SAND

(362 lb of sand required)

- Insert a **Base Plug (AEF)** into the **Base (AJM)** in the hole closest to the Pole.
- Using a funnel, fill the Base with sand through the hole furthest from the Pole until the sand is just below the hole.
- Using two adults, stand the Base up on a flat surface and finish filling the Base with sand.
- Insert the other Base Plug into the hole furthest from the Pole.



WARNING

For safety reasons, we recommend that sand be used instead of water to fill the Base. If a leak develops, water could run out unnoticed, allowing the system to fall over, resulting in serious personal injuries, or property damage. If using Water, check the Base carefully for leaks. If a leak is found, lay the system down on the ground and call Customer Service. Do not use, stand up, or play on a leaking system.





TOOLS AND HARDWARE REQUIRED FOR THIS PAGE



NO HARDWARE REQUIRED FOR THIS PAGE

Two adults are required to complete assembly. To prevent serious injuries, the Pole should be held down by one adult at all times while the Base is being filled.

SEC

6.1

OPTION B: FILLING WITH WATER

- Insert a **Base Plug (AEF)** into the **Base (AJM)** in the hole closest to the Pole.
- Fill the Base with cold water through the hole furthest from the Pole until the water is just below the hole.
- Using two adults, stand the Base up on a flat surface and finish filling the Base with water.
- Add one tablespoon of chlorine bleach to the water to prevent algae formation.
- Insert the other Base Plug into the hole furthest from the Pole.





TOOLS AND HARDWARE REQUIRED FOR THIS PAGE

NO TOOLS OR HARDWARE REQUIRED FOR THIS PAGE

SEC

6.2

Attach **Net (AKZ)** to the **Rim (ALX)**.

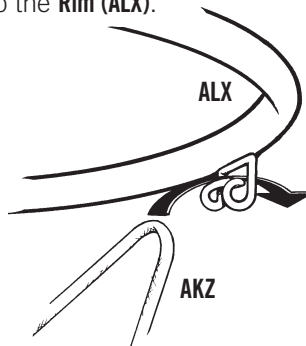

Note: If a replacement Net is needed, please call our Customer Service Department. Our Nets are shorter than average to reduce the risk of entanglement.

SEC

6.3

Pull the Handle all the way down so the system is at the highest setting. Line up the 10' mark on the **Height Sticker (AKP)** with the arrow on the **Left Handle (AKL)**, and apply the Sticker to the back of the Pole as shown.

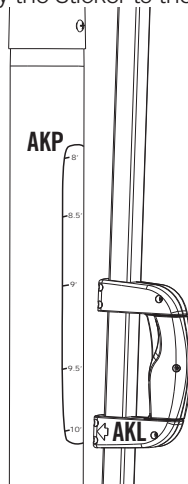

OPERATION OF HEIGHT ADJUSTMENT SYSTEM

The basketball system may be adjusted from 8 feet to 10 feet.

ONLY ADULTS SHOULD ADJUST THE HEIGHT OF THE SYSTEM.

TO ADJUST THE SYSTEM'S HEIGHT:

Hold the Handle tightly and squeeze the Trigger. Lowering the Handle will raise the Backboard. Raising the Handle will lower the Backboard.

MOVING THE SYSTEM



WARNING: The system must only be moved by people capable of handling its weight. Children should not be allowed to move the system.

- a. Adjust the system to its lowest position, and use caution to prevent the height mechanism from adjusting.
- b. Stand in front of the system and pull on the Pole until the unit is balanced on its Wheels.
- c. Move the system to the desired location and carefully set the Base down.



CAUTION: The system must only be moved on its Wheels. Sliding the Base may damage the Base which could result in leakage and the system tipping over.

POLE CARE AND SYSTEM MAINTENANCE

The life of your basketball system depends on many variables. The climate, exposure to corrosives such as salt, pesticides, or herbicides, and excessive use or misuse can all contribute to Pole failure, which may cause property damage or personal injury.

Check your basketball system frequently for loose hardware, excessive wear, and signs of corrosion. For safety reasons, and to prolong the life of your basketball system, you must take the following preventive measures.

- a. Check all Nuts and Bolts. If any are loose, tighten them.
- b. Check all parts for excessive wear and tear. If necessary, replace any parts that have been worn or damaged through usage. Contact our Customer Service Department for replacement parts.
- c. Inspect the Warning Sticker on the Pole. If it is ripped, faded, or illegible, call our Customer Service Department to request a replacement Sticker.
- d. Check all Pole sections for visible rust or chipped or cracked paint. If either are present, do the following:
 1. Use an emery cloth to completely remove any rust or chipped paint.
 2. Clean the area with a damp cloth and allow it to dry.
 3. Apply two coats of a rust preventative, high gloss enamel paint to the area. Allow the paint to dry between coats.

IF RUST HAS PENETRATED THROUGH THE POLE ANYWHERE, REPLACE IT IMMEDIATELY!

NOTES

NOTES

**ENHANCE YOUR LIFETIME® PURCHASE BY ADDING
ACCESSORIES OR OTHER GREAT PRODUCTS:**

To purchase accessories or other Lifetime Products, visit us at:

www.lifetime.com

Or call: 1-800-424-3865

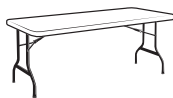



WARNING



FAILURE TO FOLLOW THESE WARNINGS MAY RESULT IN SERIOUS INJURY AND/OR PROPERTY DAMAGE.

Owners must ensure that all players know and follow these rules for safe operation of the system.

- Only hang from the rim briefly to regain balance or avoid injuring others. Release the rim as soon as safely possible.
- During play, especially when performing dunk type activities, keep player's face away from the backboard, rim, and net. Serious injury could occur if teeth/faces come in contact with the backboard, rim, or net. Player should wear a mouth guard during play.
- Do not slide, climb, or play on base or pole.
- Completely fill base according to manufacturer's instructions. Never leave the unit standing in an upright position without first filling the base with weight or the system will tip quickly causing serious personal injury.
- When adjusting height or moving system, keep hands and fingers away from moving parts.
- Do not allow children to move or adjust system.
- Do not wear jewelry (rings, watches, necklaces, etc.) during play. Objects may entangle in net.
- Keep organic material away from pole base. Grass, litter, etc. could cause corrosion and/or deterioration.
- Surface beneath the base must be smooth and free of gravel or other objects.

- Punctures cause leakage and could cause system to tip over.
- Once a month check pole and all metal parts for signs of corrosion (rust, pitting, chipping). Completely remove rust and repaint with exterior enamel. If rust has penetrated any steel part, replace that part immediately.
- Check system before each use for proper ballast, loose hardware, excessive wear, instability, and signs of corrosion and repair before use.
- Never play on damaged equipment.
- Do not use system during windy or severe weather. System may tip over. Place system in an area protected from the wind or in an area away from property that may be damaged if the system falls, and from overhead power lines.
- Do not use the system to lift or hoist anything. The mechanism is designed to lift only the weight of the backboard and rim. Do not hang anything from the handle, rim backboard, or lifter arms as this will damage the system and void the warranty.



ADVERTENCIA



AVERTISSEMENT



SI NO SE OBEDECEN ESTAS ADVERTENCIAS PUEDEN PRODUCIRSE GRAVES LESIONES Y/O DAÑOS A LA PROPIEDAD.

El propietario del sistema debe asegurarse de que todos los jugadores conozcan y respeten estas reglas para que el sistema se use en forma segura.

- Cueléguese del aro sólo en forma breve, para recuperar el equilibrio o evitar lesionar a otros jugadores. Suelte del aro lo más pronto que pueda hacerlo con seguridad.
- Durante el juego, especialmente al embocar violentamente de alto, la cara de los jugadores debe mantenerse alejada del tablero, el aro y la red. Pueden producirse lesiones graves si los dientes o la cara entran en contacto con el tablero, el aro o la red. Los jugadores deben usar un protector bucal durante el juego.
- No se deslice, no trepe ni juegue sobre la base o el poste.
- Llene la base completamente siguiendo las instrucciones del fabricante. Nunca deje la unidad en posición de uso sin haber llenado previamente la base con material de contrapeso, pues el sistema podría tumbarse rápidamente y causar graves lesiones personales.
- Mantenga las manos y los dedos alejados de las piezas móviles cuando regule la altura o desplace el sistema.
- No deje que los niños regulen ni desplacen el sistema.
• No use joyas (anillos, relojes, collares o gargantillas, etc.) durante el juego. Estos objetos pueden engancharse en la red.
- La superficie donde se coloque la base debe estar lisa y desprovista de piedras, grava u otros objetos. Las perforaciones pueden originar pérdidas, y éstas pueden hacer que el sistema se tumbe.
- No permita que la base del poste entre en contacto con materiales orgánicos. El pasto, los desechos animales, etc., pueden causar corrosión y/o deterioros.
- Controle el poste y todas las piezas metálicas una vez al mes en busca de signos visibles de corrosión (oxidación, picaduras, escamado). Elimine todo rastro de óxido y vuelva a pintar con esmalte para exteriores. Si el óxido ha penetrado cualquier pieza de acero, reemplace esa pieza de inmediato.
- Inspeccione el sistema antes de cada uso para verificar que esté adecuadamente contrapesado, que los elementos de fijación no estén flojos, que no haya desgaste excesivo, inestabilidad ni signos de corrosión. Si encuentra irregularidades, repárelas antes de usar el sistema.
- Nunca juegue con un equipo dañado.
- No use el sistema en presencia de vientos fuertes o condiciones climáticas adversas, ya que puede tumbarse. Coloque la unidad en su posición de almacenamiento y/o en una zona a resguardo del viento, lejos de propiedades personales que puedan dañarse si el sistema se cae, y de líneas de suministro de energía.
- No use el sistema para levantar ningún objeto. El mecanismo está diseñado para elevar solamente el peso del tablero con el aro. No cuelgue nada de la agarradera, el aro, el tablero ni los brazos de elevación, ya que esto puede dañar el sistema y anular la garantía.

FAUTE DE NE PAS SUIVRE CES AVERTISSEMENTS, VOUS RISQUEZ DE CAUSER DES BLESSURES GRAVES ET/OU DES DOMMAGES À L'ÉQUIPEMENT.

Le propriétaire doit s'assurer que tous les joueurs connaissent et appliquent les règles suivantes afin d'utiliser l'équipement en toute sécurité.

- Ne vous suspendez pas à l'anneau plus que nécessaire pour retrouver votre équilibre ou éviter de blesser les autres joueurs. Relâchez l'anneau aussitôt que possible.
- Lors d'un match, particulièrement dans le cas des smashes, le visage du joueur ne doit pas faire face au panneau, à l'anneau, ni au filet. Le joueur risque de graves blessures si ses dents ou son visage entrent en contact avec le panneau, l'anneau, ou le filet. Les joueurs doivent toujours porter un protège-dents lorsqu'ils jouent.
- Ne glissez pas, ne grimpez pas, et ne jouez pas sur la base ou le poteau.
- Remplissez complètement la base selon les instructions du fabricant. Ne laissez jamais l'unité debout de plein pied sans avoir d'abord rempli la base avec un poids ou l'équipement pourrait basculer rapidement et causer de graves blessures.
- Lorsque vous ajustez la hauteur ou lorsque vous déplacez l'équipement, gardez vos mains et doigts loin des pièces mobiles.
- Ne permettez pas aux enfants de déplacer ou d'ajuster l'équipement.
- Ne portez pas de bijoux (bagues, montres, colliers, etc.) lorsque vous jouez. Ces objets pourraient s'accrocher au filet.
- La surface sur laquelle est posée la base doit être lisse et sans gravier ou tout autre objet qui pourrait troubler la base entraînant ainsi une fuite ce qui pourrait faire basculer l'équipement.
- La base ne doit pas non plus être posée sur aucun type de matière organique. L'herbe, les déchets, etc. peuvent entraîner la corrosion et la détérioration de l'équipement.
- Une fois par mois, vérifiez que le Poteau et toutes les pièces en métal ne montrent pas de signes de corrosion (rouille, piqûres, écailage). Enlevez toute la rouille et repeignez complètement avec une peinture pour extérieur. Si la rouille a pénétré une des pièces en acier, vous devez remplacer immédiatement la pièce en question.
- A chaque fois que vous allez utiliser l'équipement, vérifiez d'abord l'équilibre, la possibilité de pièces desserrées ou usées, la stabilité de l'équipement et tout signe de corrosion ou réparation nécessaire avant utilisation.
- Ne jouez jamais avec un équipement endommagé.
- N'utilisez pas l'équipement lors de fortes rafales de vent ou de mauvais temps. L'équipement pourrait basculer. Placez l'équipement dans un endroit abrité du vent ou loin des structures qu'il pourrait endommager s'il basculait et loin des fils électriques.
- N'utilisez pas l'équipement pour lever ou soulever quelque ce soit. Son mécanisme a été conçu uniquement pour soutenir le poids du panneau et de l'anneau. N'accrochez rien au manche, à l'anneau, au panneau ni aux leviers sous peine d'endommager l'équipement et d'annuler la garantie.

#FS16400

10/12/2004

www.lifetime.com

WARRANTY INFORMATION

LIFETIME BASKETBALL EQUIPMENT

5-YEAR LIMITED FACTORY WARRANTY

THE MANUFACTURER RESERVES THE RIGHT TO MAKE SUBSTITUTIONS TO WARRANTY CLAIMS IF PARTS ARE UNAVAILABLE OR OBSOLETE.

1. Lifetime basketball systems are warranted to the original purchaser to be free from defects in material or workmanship for a period of five years from the date of original retail purchase. The word "defects" is defined as imperfections that impair the use of the product. Defects resulting from misuse, abuse or negligence will void this warranty. This warranty does not cover defects due to improper installation, alteration or accident. This warranty does not cover damage caused by vandalism, rusting, "acts of nature" or any other event beyond the control of the manufacturer.
2. This warranty is nontransferable and is expressly limited to the repair or replacement of defective basketball equipment. If the equipment is defective within the terms of this warranty, Lifetime Products, Inc. will repair or replace defective parts at no cost to the purchaser. Shipping charges to and from the factory are not covered and are the responsibility of the purchaser. Labor charges and related expenses for removal, installation or replacement of the basketball system or its components are not covered under this warranty.
3. This warranty does not cover scratching or scuffing of the product that may result from normal usage. In addition, defects resulting from intentional damage, negligence, unreasonable use or hanging from the net or rim will void this warranty.
4. Liability for incidental or consequential damages is excluded to the extent permitted by law. While every attempt is made to embody the highest degree of safety in all equipment, freedom from injury cannot be guaranteed. The user assumes all risk of injury resulting from the use of this product. All merchandise is sold on this condition, and no representative of the company may waive or change this policy.
5. This product is not intended for institutional or commercial use; Lifetime Products, Inc. does not assume any liability for such use. Institutional or commercial use will void the warranty.
6. This warranty is expressly in lieu of all other warranties, expressed or implied, including warranties of merchantability or fitness for use to the extent permitted by Federal and state law. Neither Lifetime Products, Inc., nor any representative assumes any other liability in connection with this product. This warranty gives you specific legal rights, and you may also have other rights which vary from state to state.

ALL WARRANTY CLAIMS MUST BE ACCOMPANIED BY A SALES RECEIPT.

REPORT PRODUCT DEFECTS IN WRITING TO:

Lifetime Products, Inc., PO Box 160010 Clearfield, UT 84016-0010, or call (800) 225-3865

M-F 7 a.m. to 5 p.m. MST.

****Call or visit our Web site for Saturday hours****

Please include your dated sales receipt and photographs of damaged parts.

To register the product, visit our Web site at www.lifetime.com



www.lifetime.com